

Arpool M

TECHNOLOGY



Flow Sense

A built-in protector against power-related issues, ensuring lasting performance and safety.



Split & Seal

Uses protective polymers to shield Filix products from water and moisture, boosting durability and resilience.



Heat Sense

Automatically reduces LED power at high temperatures, ensuring longevity and safety in Filix products.





Arpool M

Specification Sheet



UL STD 676 swimming pool rated
CSA C22.2#89 swimming pool rated
IP68

LUMINAIRE FEATURES

Design and Application

- Medium pools
- Wall and floor lighting, recessed

Mechanical details

- IK10 crystal-clear tempered glass, 10mm (0.39") thick
- IP68, rated for permanent submersion
- Maximum installation depth up to 5m (16')
- AISI316L stainless steel body
- Suitable for chlorine and marine environments
- Supplied with 3m(10') oil and water resistant feed cable as standard
- Recessed installation secured with A4 grade screws
- Galvanic protection

Electrical details

- LED Lifetime TM-21 @ 105°C
L80(24K) = 145,000 hours
- Operating temperature: -20°C (-28°F) to +50°C (122°F)
- LED CRI: >85
- 3 step MacAdam
- Remote power supply
- Low voltage operation

Sustainability

- Recyclable materials

Controls

- DMX, with compatible LED power supply
- DALI, with compatible LED power supply
- 0-10V, with compatible LED power supply
- Mains, with compatible LED power supply

Integrated systems

- Split & Seal
- Flow Sense
- Heat Sense

Links & Downloads

- [List of available drivers](#)
- [Voltage drop calculator](#)
- [Fixture installation manual](#)
- [Housing installation manual](#)
- [CAD files](#)
- [IES-LTD data](#)

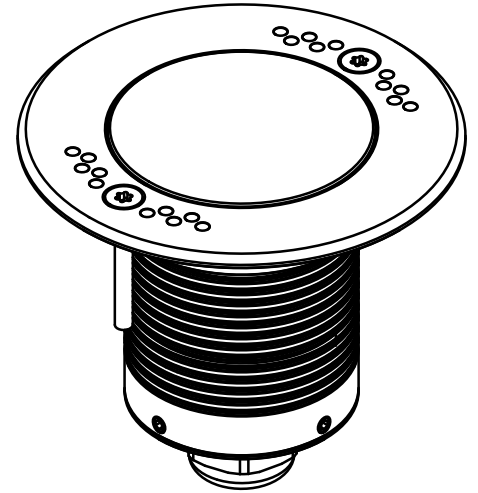

Ø100mm X H99mm

Note

Underwater luminaire – must be constantly submersed.



Arpool M

ORDERING INFORMATION

MODEL	
AM	
APPLICATION	
TM	<ul style="list-style-type: none">• TM - Ø100mm x 99mm (Ø3,9" x 3,9")
POWER	
L	<ul style="list-style-type: none">• L - 9W, 3000/4000K, 600 lm
H	<ul style="list-style-type: none">• H - 15W, 3000/4000K, 1100lm• H - 15W, RGBW (W 4000K)
COLOR TEMP.	
27	<ul style="list-style-type: none">• 27 - 2700K
30	<ul style="list-style-type: none">• 30 - 3000K
40	<ul style="list-style-type: none">• 40 - 4000K
RGBW	<ul style="list-style-type: none">• RGBW (W 4000K)
TW	<ul style="list-style-type: none">• TW - Tunable white 2200K-4000K
OPTICS	
SP	<ul style="list-style-type: none">• SP - Spot - 15°
FL	<ul style="list-style-type: none">• FL - Flood - 40°
W	<ul style="list-style-type: none">• W - Wide - 70°
SPX	<ul style="list-style-type: none">• SPX - Spot - 15° + Hex
FLX	<ul style="list-style-type: none">• FLX - Flood - 40° + Hex
WX	<ul style="list-style-type: none">• WX - Wide - 70° + Hex
VOLTAGE	
12	<ul style="list-style-type: none">• 12 - 12VDC fixture voltage
24	<ul style="list-style-type: none">• 24 - 24VDC fixture voltage
OPTIONS	
3	<ul style="list-style-type: none">• 3* - standard feed cable 3m (10')
6	<ul style="list-style-type: none">• 6 - luminaire supplied with 6m (20') feed cable
9	<ul style="list-style-type: none">• 9 - luminaire supplied with 9m (30') feed cable
20	<ul style="list-style-type: none">• 20 - luminaire supplied with 20m (65') feed cable
GLARE CONTROL	
1	<ul style="list-style-type: none">• 1 - Half Moon



Arpool M

MANDATORY ACCESSORIES

Housings

HOUSING

AM382

- AM382 - Concrete pool installation housing back feed

AM382S

- AM382S - Concrete pool installation housing side feed

AM382SP

- AM382SP - Stainless steel pool installation housing

AM382LN

- AM382LN - Liner pool installation housing

Power supplies

DRIVERS

[LINK](#)

- [List of available drivers](#)

OPTIONAL ACCESSORIES

SW

- SW - Socket wrench for cable gland



Arpool M

INSTALLATION DETAILS

Fixture

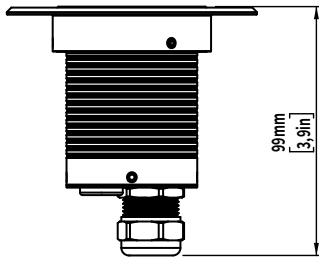

Made out of AISI316l stainless steel with additional passive coating, this luminaire is suitable for use in marine and chlorine environments. The standard luminaires are equipped with water and oil-resistant cables in various standard lengths. with integrated systems such as Flow Sense, Heat Sense, and Split & Seal, the luminaire has all the needed protective barriers.

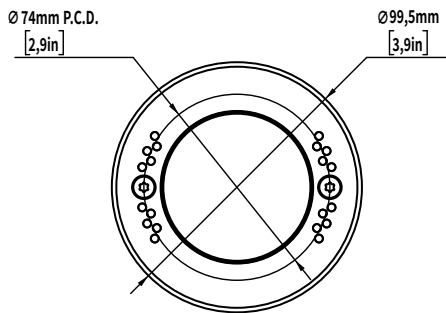

Note:
For details on specific depths, tiling thickness and other please refer to both Installation instructions for fixture and housing.



Arpool M

HOUSING

AM382 - Concrete Pool Installation back feed

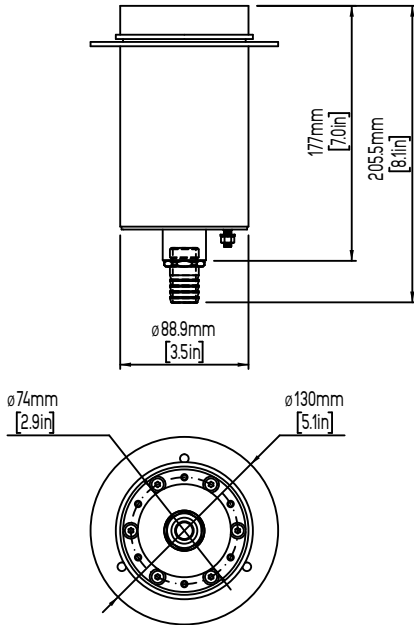

AM382S - Concrete Pool Installation side feed

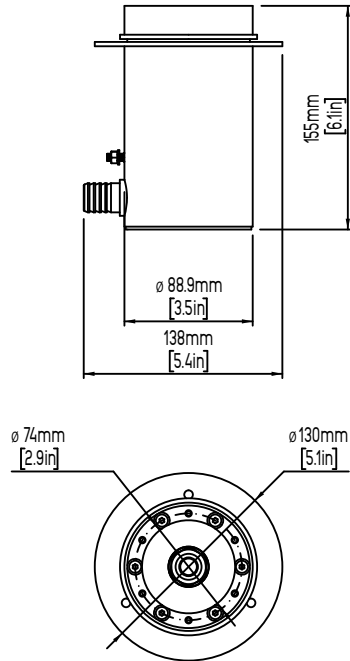

AM382SP - Stainless Steel Pool Installation

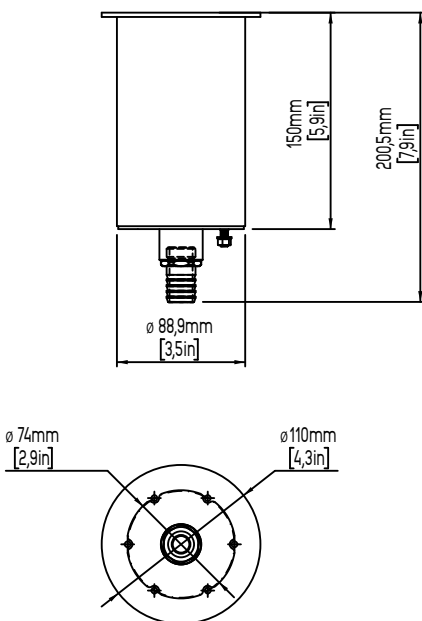

AM382LN - Liner Pool Installation

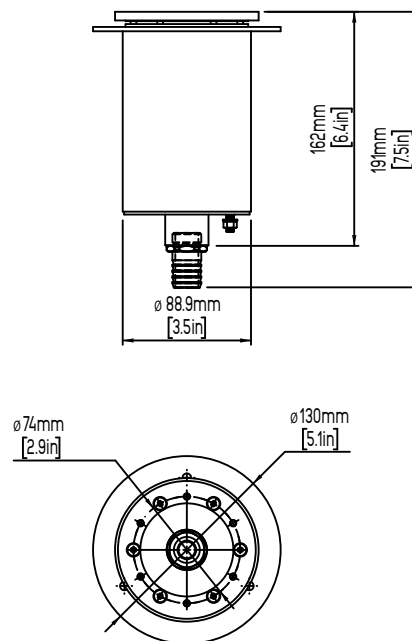

Note:
For details on specific depths, tiling thickness and other please refer to both Installation instructions for fixture and housing.



Arpool M

MANDATORY ACCESSORIES

Stainless steel installation housing

Used to niche used to seamlessly integrate luminaire utilizing precision press fit with no exposed hardware.

Made out of stainless steel with single cable entry and suitable for marine and pool environments. Standard features include a 1.5m oil and water-resistant cable conduit, streamlining the installation process. Due to its size, the housing's back end intentionally lacks a sealed cable gland. Contractors are advised to review installation instructions for proper guidance.

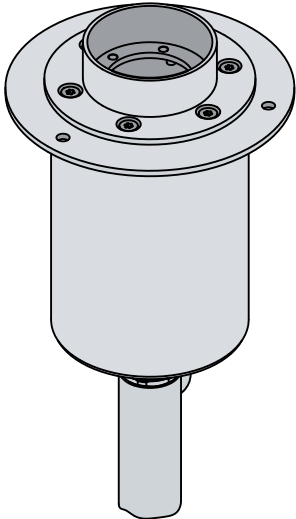

Power supply

A LED power supply, is an electrical device designed to control the power supplied to an LED or an array of LEDs. It plays a critical role in LED lighting systems as LEDs demand a specific type and level of electrical current or voltage for optimal operation. It's important to note whether a constant current or constant voltage LED power supply is required. The power supply should be installed in a dry and easily accessible area.

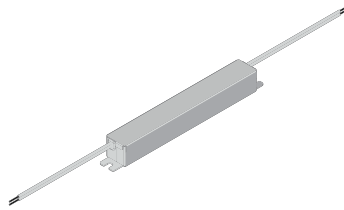



Arpool M

GLARE CONTROL

Internal glare control:

Hex louvre

Provides low glare control with 45% less lumen output than product without louvres. Best for use when there is no need for segment beam cut off such as in half moon

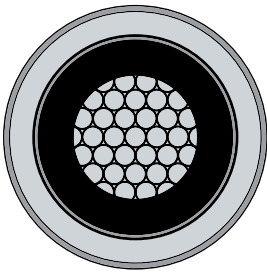

Half moon

Provides glare control by reducing lumen output and implementing a light beam cut-off, resulting in a 50% reduction in stray light and minimized light dispersion in undesirable directions.

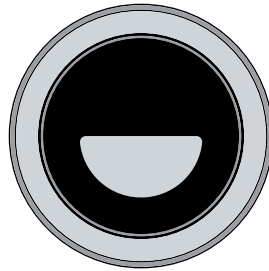

Honeymoon

Combines the benefits of Hex Louvre and Halfmoon, offering both reduced glare and controlled light dispersion for comprehensive glare management.





Arpool M

OPTICS

Spot
Angle: 15°
Delivered lumen: 1100lm

Flood
Angle: 40°
Delivered lumen: 800lm

Wide
Angle: 70°
Delivered lumen: 600lm

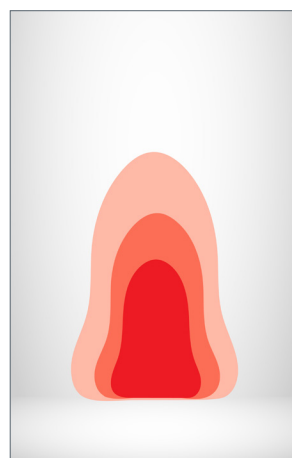
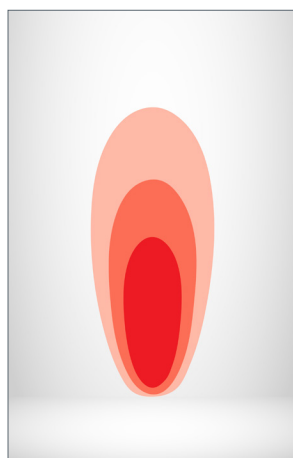
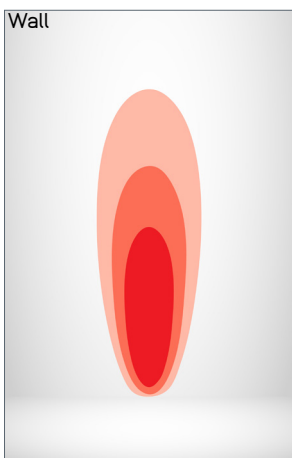
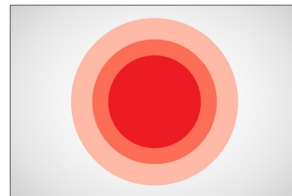
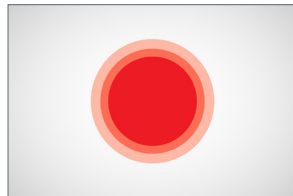
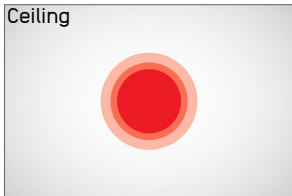

Spot + Hex
Angle: 15°
Delivered lumen: 550lm

Flood + Hex
Angle: 40°
Delivered lumen: 385lm

Wide + Hex
Angle: 70°
Delivered lumen: 275lm

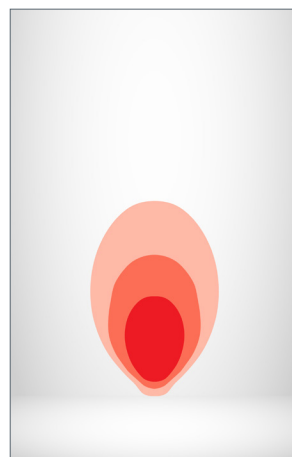
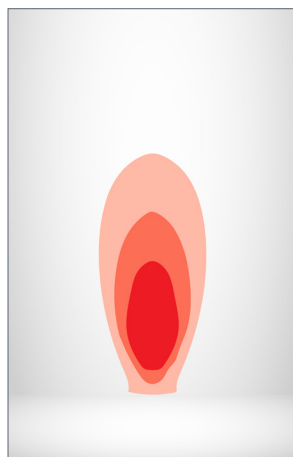
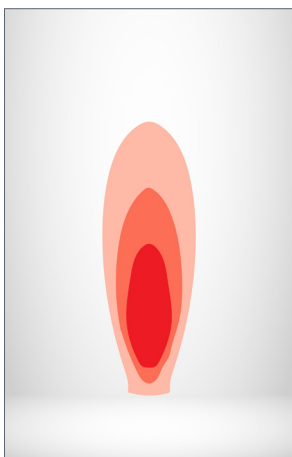
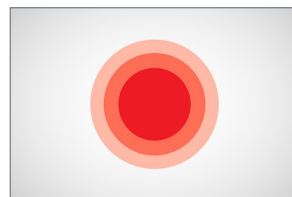
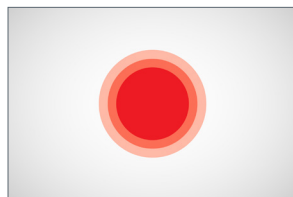
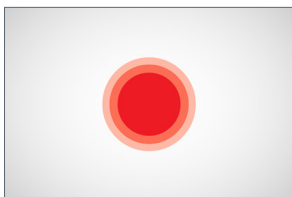

Notes

- Light output values based on 15W and 3000K product



Control

ON/OFF SYSTEM TOPOLOGY

Integrated systems:

- Heat Sense
- Flow Sense
- Split & Seal

System components

- Wiring and additional accessories leading up to the product feed cable are the responsibility of others.
- Housing and necessary accessories that are marked as mandatory must be ordered separately

System topology

- In the system design, any of the following system topologies can be utilized: line wiring, star wiring, or tree wiring.

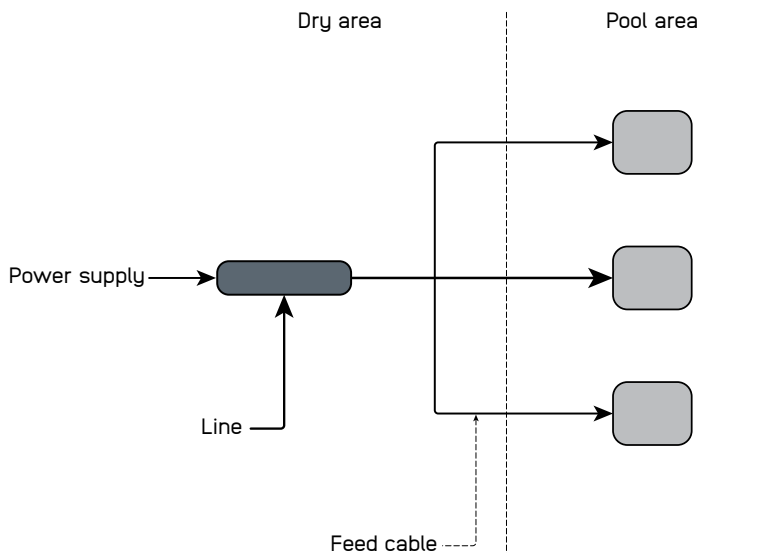

Addressing & dimming notes

- ON/OFF system does not allow device addressing
- Dimming of the product not available in this system

Segment length and limitations

- All wire splicing should be performed in a dry area to ensure a proper connection.
- Used in single colour applications

Fault tolerance

- If one product fails, the rest of the system continues to work.



Control

0-10V SYSTEM TOPOLOGY

Integrated systems:

- Heat Sense
- Flow Sense
- Split & Seal

System components

- The 0-10V system, wiring and additional accessories leading up to the product feed cable are the responsibility of others.
- Housing and necessary accessories that are marked as mandatory must be ordered separately

System topology

- In the system design, any of the following system topologies can be utilized: line wiring, star wiring, or tree wiring.

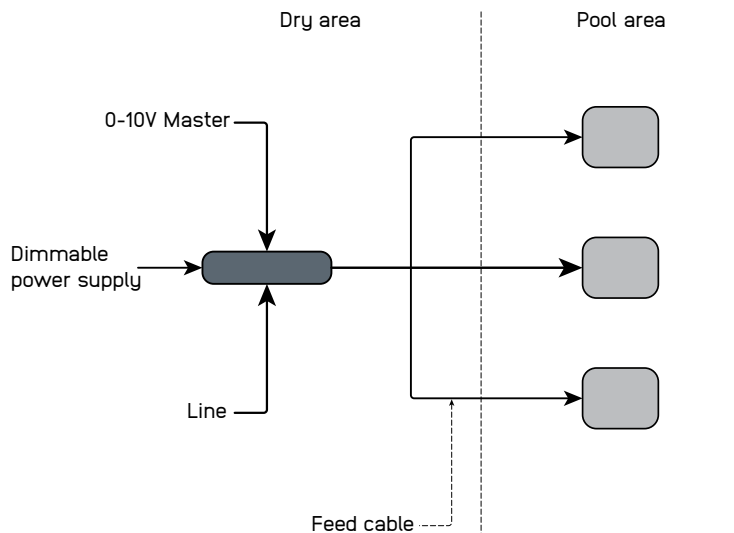

Addressing & dimming notes

- Without 0-10V dimmable power supply product can not be controled
- Individual device addressing can be achieved by connecting each product to a separate output channel of the 0-10V dimmable power supply.
- Logarithmic and linear dimming options depend on the 0-10V dimmable LED power supply
- The dimming range is determined by the 0-10V dimmable LED power supply

Segment length and limitations

- The minimum controllable segment is one product.
- All wire splicing should be performed in a dry area to ensure a proper connection.
- Used in single colour applications

Fault tolerance

- If the LED driver is source type and in the case the control line doesn't have power the light fitting will turn at 100%. in the opposite case where the LED power supply is sink type, light will not work.
- If one product fails the rest of the system continues to work.



Control

DALI SYSTEM TOPOLOGY

Integrated systems:

- Heat Sense
- Flow Sense
- Split & Seal

System components

- The DALI system, wiring and additional accessories leading up to the product feed cable are the responsibility of others.
- Housing and necessary accessories that are marked as mandatory must to be ordered separately

System topology

- In the system design, any of the following system topologies can be utilized: line wiring, star wiring, or tree wiring.

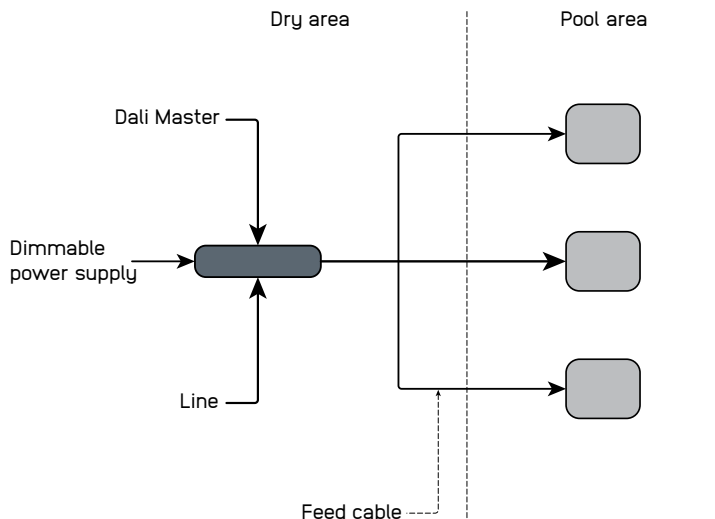

Addressing & dimming notes

- Without a DALI dimmable power supply, the product cannot be controlled.
- Individual device addressing (short address) and group addresses for up to 16 groups can be achieved by connecting each group of products to a separate output channel of the DALI dimmable power supply. A broadcast address targets everything on the line of the DALI dimmable LED driver.
- Logarithmic and linear dimming options depend on the DALI dimmable LED power supply.
- The dimming range is determined by the DALI dimmable LED power supply.

Segment length and limitations

- The minimum controllable segment is one product.
- A DALI dimmable power supply cannot control fittings individually unless they are connected to separate channels of a DALI dimmable power supply.
- All wire splicing should be performed in a dry area to ensure a proper connection.
- Suitable for both single-color and multi-color applications.

Fault tolerance

- If one product fails, the rest of the system continues to work.



Control

DMX SYSTEM TOPOLOGY

Integrated systems:

- Heat Sense
- Flow Sense
- Split & Seal

System components

- The DMX system, wiring and additional accessories leading up to the product feed cable are the responsibility of others.
- Housing and necessary accessories that are marked as mandatory must be ordered separately

System topology

- In the system design, any of the following system topologies can be utilized: line wiring, star wiring, or tree wiring.

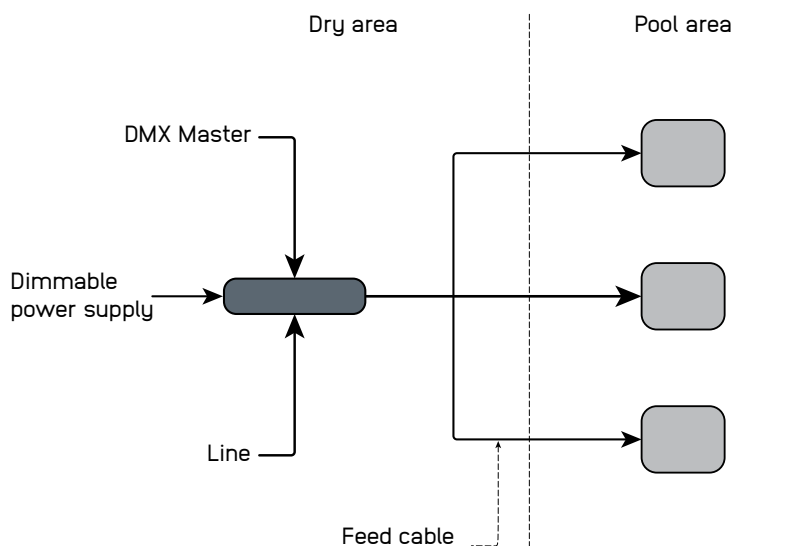

Addressing & dimming notes

- The minimum controllable segment is one product.
- A DMX dimmable power supply cannot control fittings individually unless they are connected to separate channels of a DMX dimmable power supply.
- In a parallel connection of multiple fittings, the maximum distance between the LED power supply and the last fitting in line is limited to the maximum allowed voltage drop.
- In a serial connection of multiple fittings, the maximum length of a cable loop is 50 meters, and the electrical circuit size is limited by power supply ratings, such as output voltage range.
- All wire splicing should be performed in a dry area to ensure a proper connection.

Segment length and limitations

- Without a DMX dimmable power supply, the product cannot be controlled.
- Individual device addressing (short address) and group addresses can be achieved by connecting each product or a group to a separate output channel of the DMX dimmable power supply.
- Logarithmic and linear dimming options depend on the DMX dimmable LED power supply.
- The dimming range is determined by the DMX dimmable LED power supply.
- Suitable for both single-color and multi-color applications.

Fault tolerance

- If one product fails, the rest of the system continues to work.