

SQT 100 Tilt Adjustable

TECHNOLOGY



Flow Sense

A built-in protector against power-related issues, ensuring lasting performance and safety.



Split & Seal

Uses protective polymers to shield Filix products from water and moisture, boosting durability and resilience.



Heat Sense

Automatically reduces LED power at high temperatures, ensuring longevity and safety in Filix products.





SQT100 Tilt Adjustable

Specification Sheet



UL STD 1598
IP67

LUMINAIRE FEATURES

Design and Application

- Square recessed floor installation
- Architectural and landscape lighting
- Large outdoor and interior lobby spaces

Mechanical details

- IK10 crystal-clear tempered glass, 10mm (0.39") thick
- AISI304L stainless steel and aluminum body
- Adjustable beam 20 degrees
- Snap in installation with no exposed hardware
- Wet location, drive over rated 1500 kg (3300lb)
- Supplied with 0.3m (1') oil and water resistant feed cable as standard

Electrical details

- LED Lifetime TM-21 @ 85°C
L90(10K) = 60,500 hours
- Operating temperature: -20°C (-28°F) to +40°C (104°F)
- LED CRI: >85
- 2 step MacAdam

Sustainability

- Recyclable materials
- Replaceable LED module

Controls

- DMX, with compatible LED power supply
- DALI, with compatible LED power supply
- 0-10V, with compatible LED power supply
- Mains, with compatible LED power supply

Integrated systems

- Split & Seal
- Flow Sense
- Heat Sense

Links & Downloads

- [List of available drivers](#)
- [Voltage drop calculator](#)
- [Fixture installation manual](#)
- [Housing installation manual](#)
- [CAD files](#)
- [IES-LTD data](#)



SQT100 Tilt Adjustable

ORDERING INFORMATION

MODEL

SQT100

INSTALATION

TM

- Trim (TM)

TS

- Trimless (TS)

POWER

H

- H - 10W, 2700K - 3000K, 690 lm

COLOR TEMP.

27

- 27 - 2700K

30

- 30 - 3000K

OPTICS

SP

- SP - Spot - 17°

FL

- FL - Flood - 31°

SPX

- SX - Spot - 17° + hex

FLX

- FX - Flood - 31° + hex

VOLTAGE

24

- 24 - 24VDC fixture voltage



SQT100 Tilt Adjustable

MANDATORY ACCESSORIES

Housings

HOUSING

SQ100C

SQ100T

- SQ100C - Trim installation housing of SQT100
- SQ100T - Trimless installation housing of SQT100

Feed Cable

LENGTHS

3

6

9

- 3 - luminaire supplied with 3m (10') feed cable
- 6 - luminaire supplied with 6m (20') feed cable
- 9 - luminaire supplied with 9m (30') feed cable

Power supplies

DRIVERS

[LINK](#)

- List of available drivers



SQT100 Tilt Adjustable INSTALLATION DETAILS

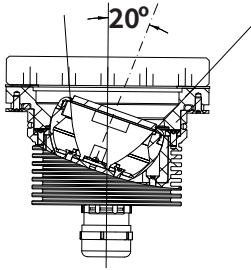

Adjustable beam tilt

Fixture has internal 20-degree adjustable beam tilt mechanism, that provides precise and adaptable illumination.

Fixture

Trim

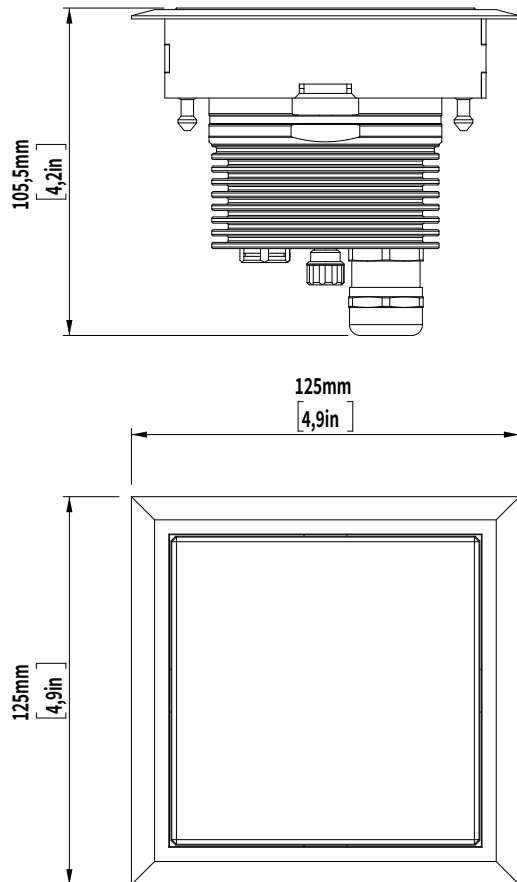

Trimless

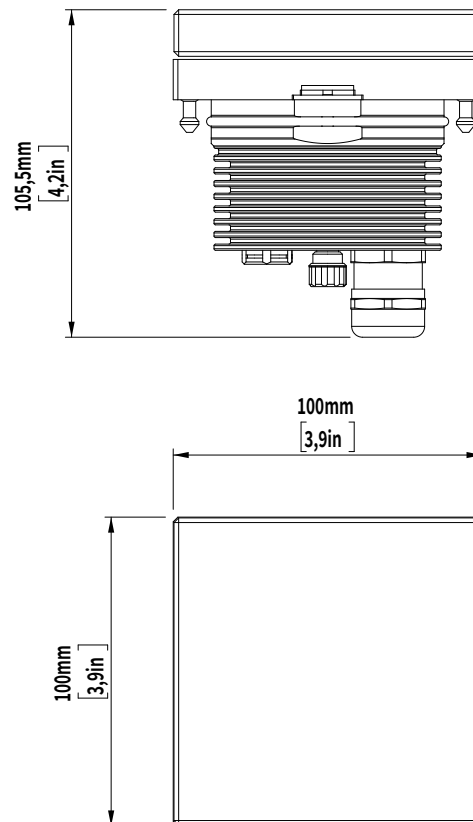

Note:
For details on specific depths, tiling thickness and other please refer to both Installation instructions for fixture and housing.



SQT100 Adjustable Tilt

INSTALLATION DETAILS

Housing

SQ100C - Trim installation housing

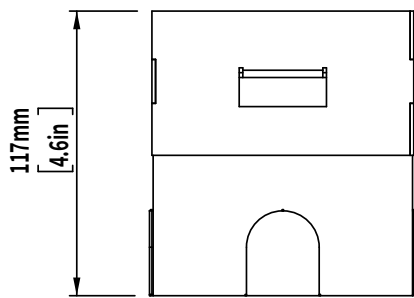

SQ100T - Trimless installation housing

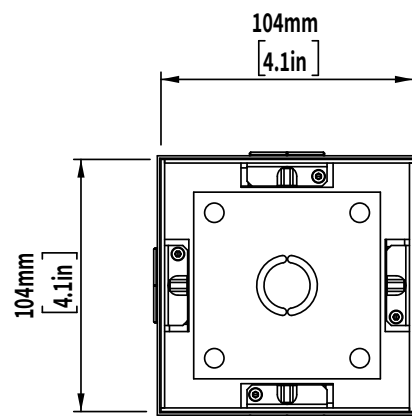
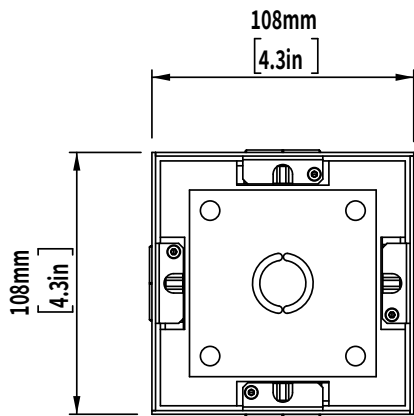
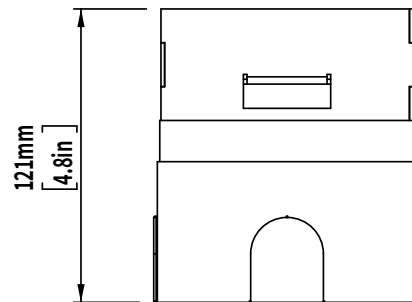

Note:
For details on specific depths, tiling thickness and other please refer to both Installation instructions for fixture and housing.



SQT100 Tilt Adjustable

MANDATORY ACCESSORIES

Installation housing

Used to niche and to seamlessly integrate luminaire utilizing precision press fit with no exposed hardware.

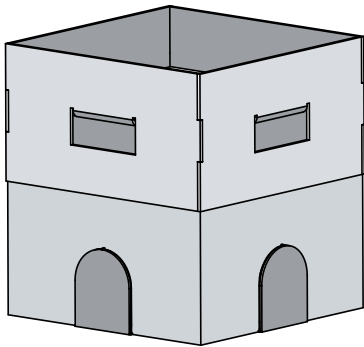

Feed cable

Length options 3m (10ft), 6m (20ft), 9m (30ft). The rugged rubber cables are versatile, with open wires for mains connection and a snap-in connector for fixture connection. They're rated IP68/IP69K and resistant to UV exposure, ideal for marine use. Note that feed cable is mandatory to order.

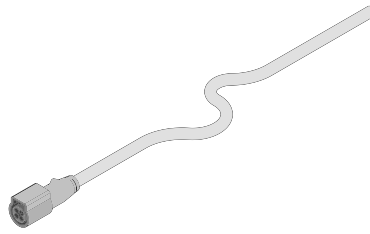

Power supply

A LED power supply, is an electrical device designed to control the power supplied to an LED or an array of LEDs. It plays a critical role in LED lighting systems as LEDs demand a specific type and level of electrical current or voltage for optimal operation. It's important to note whether a constant current or constant voltage LED power supply is required. The power supply should be installed in a dry and easily accessible area.

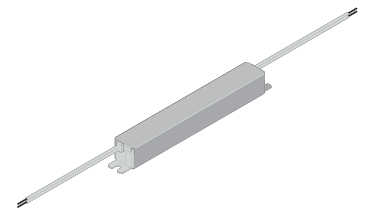



SQT100 Tilt Adjustable

LIGHT CONTROL

Internal light control:

Hex louvre

Provides low glare control with 45% less lumen output than product without louvres. Best for use when there is no need for segment beam cut off such as in half moon

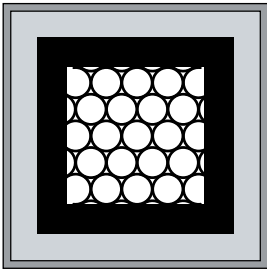



SQT100 Tilt Adjustable

OPTICS

Spot
Angle: 17°
Delivered lumen: 690lm

Flood
Angle: 31°
Delivered lumen: 580lm

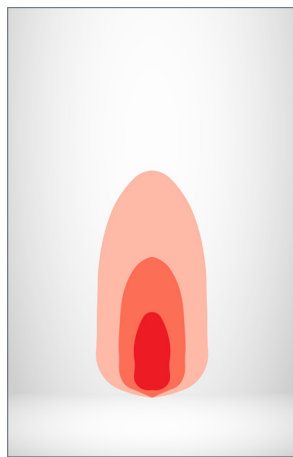
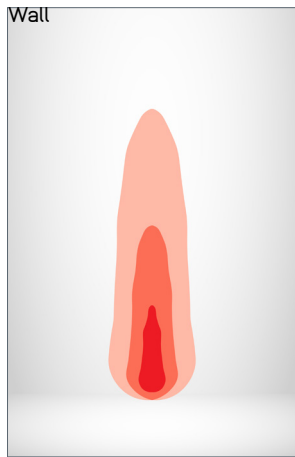
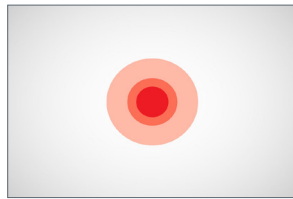
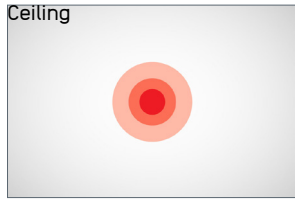

Notes

- Light output values based on 10W and 3000K product



Control

ON/OFF SYSTEM TOPOLOGY

Integrated systems:

- Flow Sense
- Heat Sense
- Split & Seal

System components

- Wiring, protective devices and junction boxes leading up to feed cable at the start of the line are the responsibility of others

System topology

- In the system design, any of the following system topologies can be utilized: line wiring, star wiring, or tree wiring.

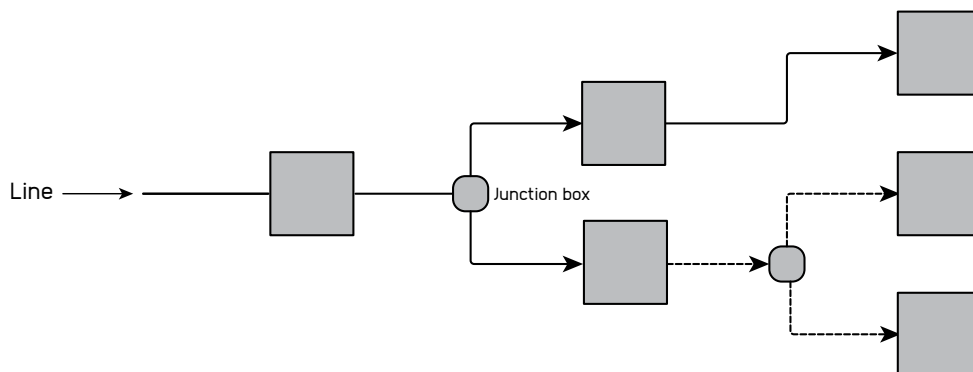

Addressing & dimming notes

- ON/OFF system does not allow device addressing
- Dimming of the product not available in this system

Segment length and limitations

- The maximum distance between the first and last fitting is limited to maximum voltage drop and fuse rating.
- Used only in single colour applications

Fault tolerance

- If one product fails the rest of the system continues to work
- Class III wiring implemented in the fixture and voltage fluctuation filter implemented



Control

0-10V SYSTEM TOPOLOGY

Integrated systems:

- Flow Sense
- Heat Sense
- Split & Seal

System components

- The 0-10V system, wiring, protective devices and junction boxes leading up to feed cable at the start of the line are the responsibility of others

System topology

- In the system design, any of the following system topologies can be utilized: line wiring, star wiring, or tree wiring.

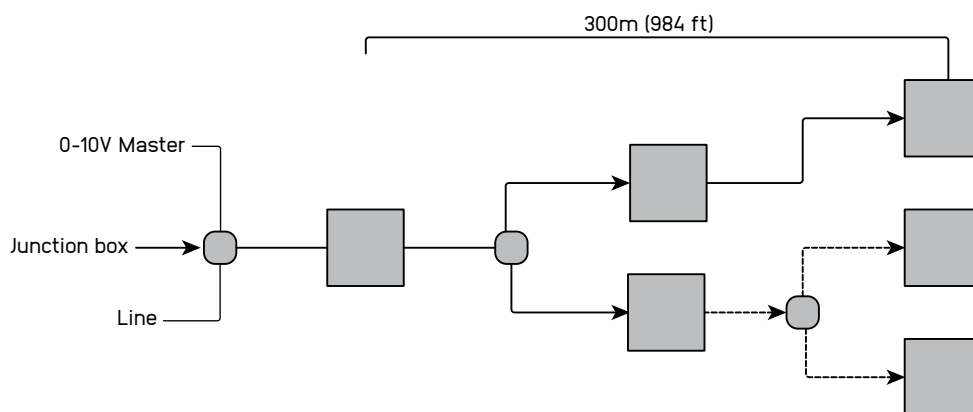

Addressing & dimming notes

- 0-10V protocol does not allow addressing devices individually
- Logarithmic and linear dimming options available. The product is initially equipped with logarithmic dimming settings and it is suggested for the controllers to be linear in order to get the dimming that is most preferred in most cases due to the dimming curve perceived by human eye
- 0%-100% dimming range
- The product is initially set up as a source instead of as a sink type
- The product could also be set up as a sink type but this should be noted to sales representative

Segment length and limitations

- The maximum distance between two fittings is 30 meters, and the maximum distance between the first and last fitting is 300 meters.
- Used in single colour applications

Fault tolerance

- If the product is source type and in the case the control line doesn't have power the light fitting will turn at 100%. in the opposite case where the light is sink type, light will not work.
- If one product fails the rest of the system continues to work
- Class III wiring implemented in the fixture and voltage fluctuation filter implemented



Control

DALI SYSTEM TOPOLOGY

Integrated systems:

- Flow Sense
- Heat Sense
- Split & Seal

System components

- The DALI system, wiring, protective devices and junction boxes leading up to feed cable at the start of the line are the responsibility of others

System topology

- In the system design, any of the following system topologies can be utilized: line wiring, star wiring, or tree wiring.

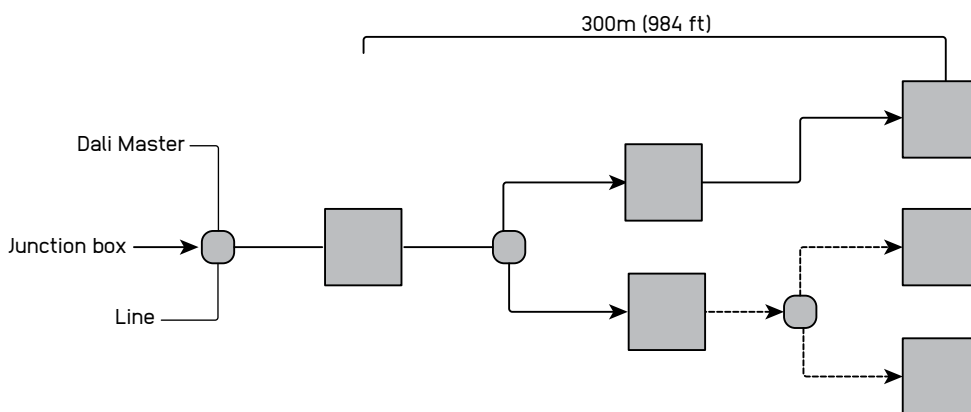

Addressing & dimming notes

- DALI protocol allows addressing devices individually
- Addressing methods include a short address for individual devices, group addresses for up to 16 groups, and a broadcast address that targets everything on the line.
- Logarithmic and linear dimming options available. the product is initially equipped with logarithmic dimming settings, while you can easily switch to logarithmic dimming using a configuration device.
- 0%-100% dimming range

Segment length and limitations

- A DALI master has the capacity to manage a line containing a maximum of 64 devices. Each device can be allocated to 16 unique groups and 16 individual scenes.
- The maximum distance between two fittings is 30 meters [98ft] , and the maximum distance between the first and last fitting is 300m [984ft].
- Used in single colour and tunable white applications

Fault tolerance

- Due to its relatively slow operating speed and high bus voltage, the DALI system exhibits significant reliability in the presence of electrical interference, making shielding unnecessary
- If one product fails the rest of the system continues to work



Control

DMX SYSTEM TOPOLOGY

Integrated systems:

- Flow Sense
- Heat Sense
- Split & Seal

System components

- The DMX system, wiring, protective devices and junction boxes of the line are the responsibility of others

System topology

- In the system design, line wiring can only be used

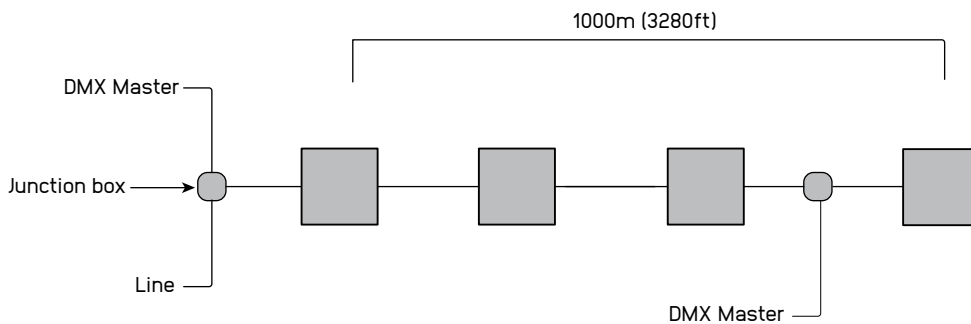

Addressing & dimming notes

- DMX protocol allows addressing devices individually
- Addressing methods allow short address for individual devices
- Logharitmic and linear dimming options available. the product is initially equipped with logarithmic dimming settings, while you can easily switch to logarithmic dimming using a configuration device.
- 0%-100% dimming range

Segment length and limitations

- A DMX universe has the capacity to manage a line containing a maximum of 512 addresses. Each Luminaire can be allocated to maximum 4 unique addresses.
- The maximum distance between two fittings is 30m (98ft), and the maximum distance between the first and last fitting is 1000 meters.
- Used in single colour, tunable white, and RGBW applications
- DMX addresses can be programmed in factory or on site. Consult your sales representative if addressing is to be done in factory

Fault tolerance

- If one product fails the rest of the system continues to work