

Arpool Linear Surface

TECHNOLOGY



Flow Sense

A built-in protector against power-related issues, ensuring lasting performance and safety.



Split & Seal

Uses protective polymers to shield Filix products from water and moisture, boosting durability and resilience.



Heat Sense

Automatically reduces LED power at high temperatures, ensuring longevity and safety in Filix products.

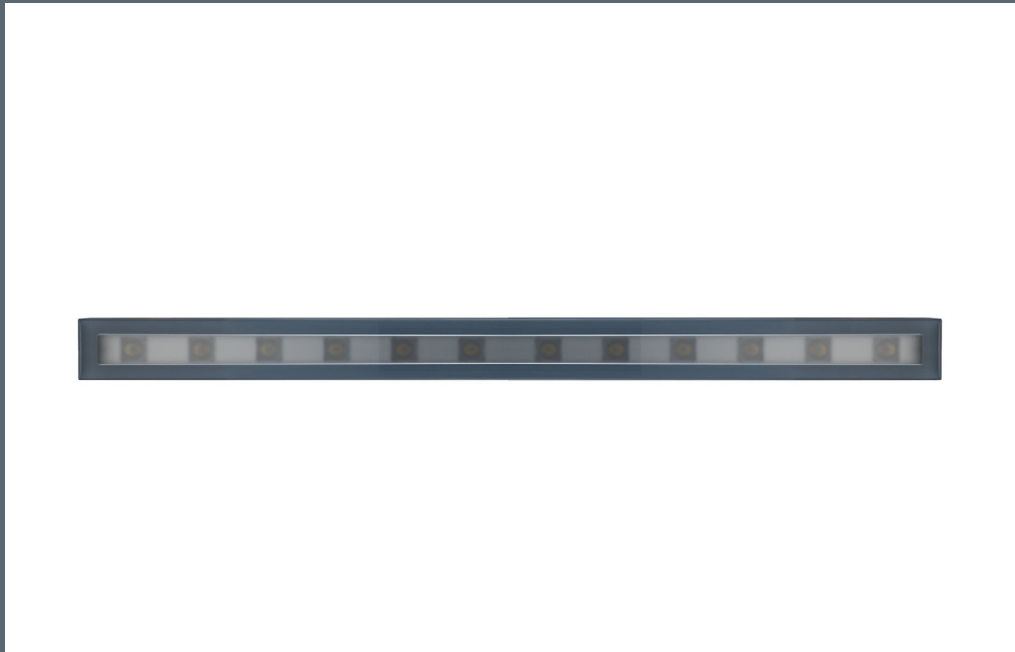



Arpool Linear Surface

Specification Sheet



UL STD 676 swimming pool rated
CSA C22.2#89 swimming pool rated
IP68

LUMINAIRE FEATURES

Design and Application

- Medium to large-scale pools
- High output surface linear light

Mechanical details

- IK10 crystal-clear tempered glass, 10mm (0.39") thick
- IP68, rated for permanent submersion
- Maximum installation depth up to 5m (16')
- AISI316L stainless steel body
- Suitable for chlorine and marine environments
- Supplied with 3m(10') oil and water resistant feed cable as standard
- Surface installation secured with A4 grade screws

Electrical details

- LED Lifetime TM-21 @ 105°C L80(17K) = 103,000 hours
- Operating temperature: -20°C (-28°F) to +50°C (122°F)
- LED CRI: >85
- 3 step MacAdam
- Remote power supply
- Low voltage operation

Sustainability

- Recyclable material

Controls

- DMX, with compatible LED power supply
- DALI, with compatible LED power supply
- 0-10V, with compatible LED power supply
- Mains, with compatible LED power supply

Integrated systems

- Split & Seal
- Flow Sense
- Heat Sense

Links & Downloads

- [List of available drivers](#)
- [Voltage drop calculator](#)
- [Fixture installation manual](#)
- [CAD files](#)
- [IES-LTD data](#)



Arpool Linear Surface

ORDERING INFORMATION

| | |
|-------------------------------|---|
| MODEL | |
| ALS | |
| LENGHT | |
| 320 | • 320mm (12,6") |
| 620 | • 620mm (24,4") |
| POWER | |
| L | • L - 39W/m, 2700/3000K/4000K, 3060lm/m |
| H | • H - 63W/m, 2700/3000/4000K, 4450lm/m |
| | • L - 47W/m, TW 2200-4000K |
| | • L - 47W/m, RGBW (W 4000K) |
| COLOR TEMP. | |
| 27 | • 27 - 2700K |
| 30 | • 30 - 3000K |
| 40 | • 40 - 4000K |
| T6 | • T6 - Tuneable white (2200-4000K) |
| M5 | • M5 - RGBW (W 4000K) |
| OPTICS | |
| SP | • SP - Spot (17°) |
| NF | • NF - Flood (30°) |
| 2Y | • 2Y - Graze (14°x40°) |
| 6Y | • 6Y - Graze with tilt (14°x40° + tilt 20°) |
| MY | • MY - Graze Wide (10°x60°) |
| VOLTAGE | |
| 12 | • 12 - 12VDC fixture voltage |
| 24 | • 24 - 24VDC fixture voltage |
| OPTIONS | |
| 03 | • 03* - Standard feed cable 3m (10') |
| 06 | • 06 - Luminaire supplied with 6m (20') feed cable |
| 09 | • 09 - Luminaire supplied with 9m (30') feed cable |
| 15 | • 15 - Luminiare supplied with 15m (50') feed cable |
| 20 | • 20 - Luminaire supplied with 20m (65') feed cable |
| INTERNAL LIGHT CONTROL | |
| 2 | • 2 - Hex Louvre |
| 4 | • 4 - Half Moon |
| 5 | • 5 - Honeymoon |



Arpool Linear Surface

MANDATORY ACCESSORIES

Power supplies

DRIVERS

[LINK](#)

- List of available drivers

OPTIONAL ACCESSORIES

Various Accessories

WWD

- WWD - Adjustable waterproof wall duct



Arpool Linear Surface INSTALLATION DETAILS

Fixture

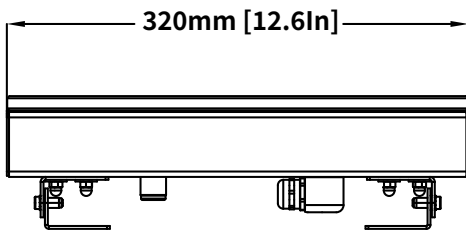
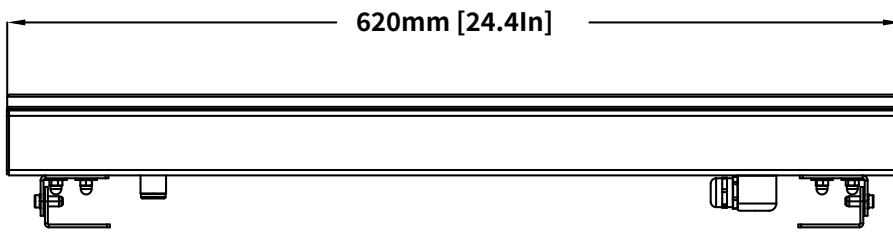

Made out of AISI316l stainless steel with additional passive coating, this luminaire is suitable for use in marine and chlorine environments. The standard luminaires are equipped with water and oil-resistant cables in various standard lengths. with integrated systems such as Flow Sense, Heat Sense, and Split & Seal, the luminaire has all the needed protective barriers.

Note:
For details on specific depths, tiling thickness and other please refer to both Installation instructions for fixture and housing.



Arpool Linear Surface

MANDATORY ACCESSORIES

Power supply

A LED power supply, is an electrical device designed to control the power supplied to an LED or an array of LEDs. It plays a critical role in LED lighting systems as LEDs demand a specific type and level of electrical current or voltage for optimal operation. It's important to note whether a constant current or constant voltage LED power supply is required. The power supply should be installed in a dry and easily accessible area.

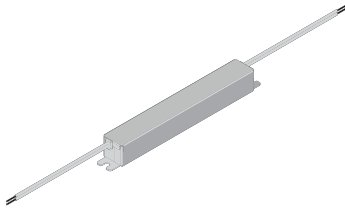

OPTIONAL ACCESSORIES

Waterproof wall duct

Ensures a secure, watertight transition between the water body and the concrete shell, with adjustable features to accommodate different wall thicknesses.

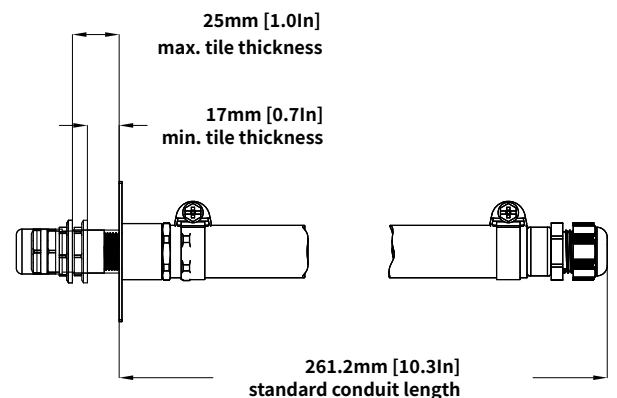
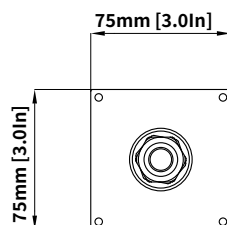
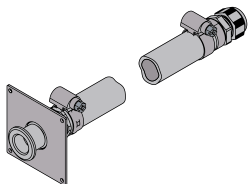



Arpool Linear Surface

LIGHT CONTROL

Internal light control:

Hex louvre

Provides low glare control with 45% less lumen output than product without louvres. Best for use when there is no need for segment beam cut off such as in half moon.

Half moon

Provides glare control by reducing lumen output and implementing a light beam cut-off, resulting in a 50% reduction in stray light and minimized light dispersion in undesirable directions.

Honeymoon

Combines the benefits of Hex Louvre and Halfmoon, offering both reduced glare and controlled light dispersion for comprehensive glare management.

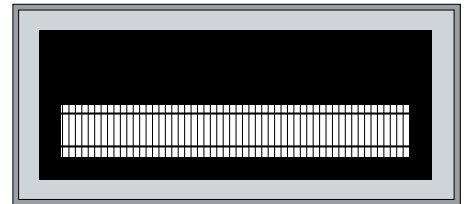
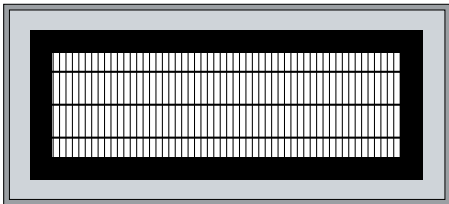



Arpool Linear Surface

OPTICS

Spot
Angle: 17°
Delivered lumen: 3060lm/m

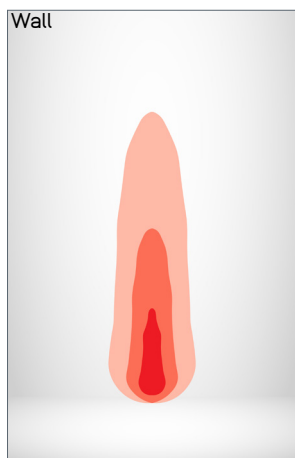
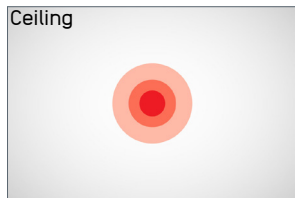

Flood
Angle: 30°
Delivered lumen: 2720lm/m

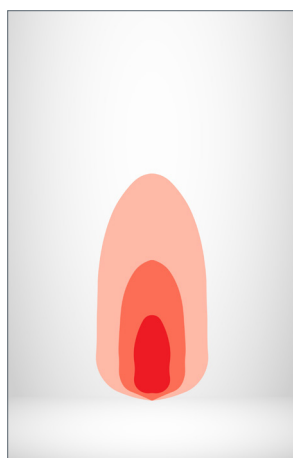
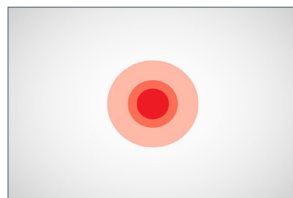

Graze
Angle: 14°x40°
Delivered lumen: 3015lm/m

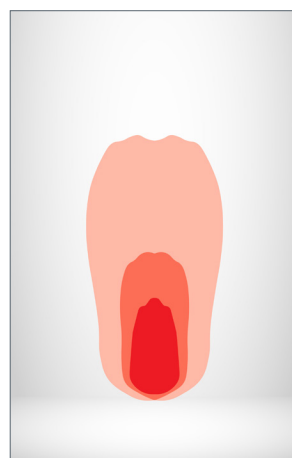
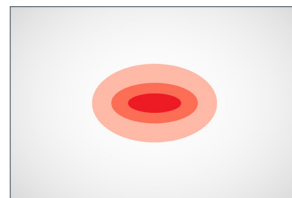

Graze Wide
Angle: 10°x60°
Delivered lumen: 2230lm/m

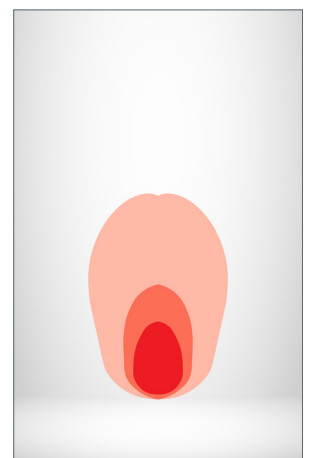
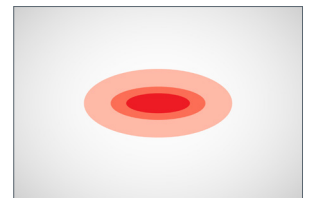

Graze with tilt
Angle: 14°x40° + tilt 20°
Delivered lumen: 2900lm/m

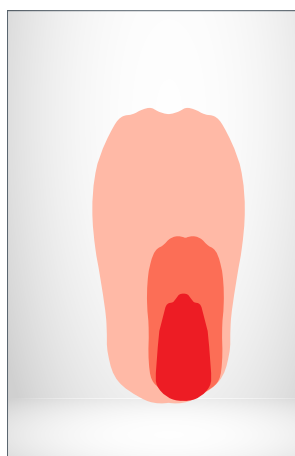
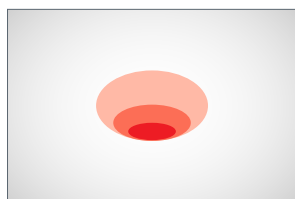

Notes

- Light output values based on 39W/m and 4000K product



Control

PWM SYSTEM TOPOLOGY - CONSTANT VOLTAGE

System components

- The luminaire is supplied with a factory-installed feed cable in standard lengths for connection to the PSU circuit, and mounting hardware as specified in the installation instructions.
- A remote constant voltage power supply (12V / 24V DC), DC distribution cabling between the PSU and luminaires (if required), junction boxes, connection infrastructure, and the control system (DALI, DMX, 0–10V or switching) must be provided by the installer or customer.
- Recommended components:
 - Surge protection on the AC side of the PSU
 - Appropriately sized DC cabling to limit voltage drop
 - Connectors and junction boxes suitable for the installation environment

System topology

- In the system design, any of the following system topologies can be utilized: line wiring, star wiring, or tree wiring.

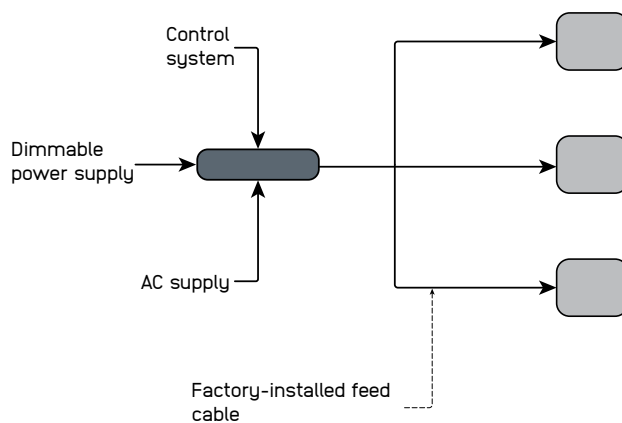

Addressing & dimming notes

- Constant voltage systems use a parallel connection topology typical for constant voltage lighting systems. Distribution layouts may include star topology, tree topology, or daisy-chain distribution.
- Individual device or channel addressing can be achieved by connecting each product to a separate output channel of the DALI or DMX dimmable power supply.
- The PSU adjusts output power according to the control signal using PWM dimming.
- Dimming options depend on the PSU and the selected control system.

Segment length and limitations

- The minimum controllable segment is one product
- Maximum cable length and number of luminaires depend on the PSU, total system wattage, conductor cross-section, and acceptable voltage drop.
- Voltage drop must remain within 10% of the nominal input voltage to ensure uniform light output.
- Dimming options depend on the PSU and the selected control system.

Fault tolerance

- Failure of the control system or communication bus does not interrupt luminaire operation if the PSU continues to supply power.
- Failure of one luminaire does not affect other luminaires connected to the same distribution line due to the parallel connection topology.
- System reliability depends on correct PSU sizing and proper electrical installation.