

## Arpool M

### TECHNOLOGY



#### Flow Sense

A built-in protector against power-related issues, ensuring lasting performance and safety.



#### Split & Seal

Uses protective polymers to shield Filix products from water and moisture, boosting durability and resilience.



#### Heat Sense

Automatically reduces LED power at high temperatures, ensuring longevity and safety in Filix products.





## Arpool M

Specification Sheet



UL STD 676 swimming pool rated  
CSA C22.2#89 swimming pool rated  
IP68

## LUMINAIRE FEATURES

### Design and Application

- Medium-scale pools and water features
- Medium output recessed spotlight

### Mechanical details

- IK10 crystal-clear tempered glass, 10mm (0.39") thick
- IP68, rated for permanent submersion
- Maximum installation depth up to 5m (16')
- AISI316L stainless steel body
- Suitable for chlorine and marine environments
- Supplied with 3m(10') oil and water resistant feed cable as standard
- Recessed installation secured with A4 grade screws
- Equipotential bonding point available with stainless steel housing

### Electrical details

- LED Lifetime TM-21 @ 105°C  
L80(24K) = 145,000 hours
- Operating temperature: -20°C (-28°F) to +50°C (122°F)
- LED CRI: >85
- 3 step MacAdam
- Remote power supply
- Low voltage operation

### Sustainability

- Recyclable material

### Controls

- DMX, with compatible LED power supply
- DALI, with compatible LED power supply
- 0-10V, with compatible LED power supply
- Mains, with compatible LED power supply

### Integrated systems

- Split & Seal
- Flow Sense
- Heat Sense

### Links & Downloads

- [List of available drivers](#)
- [Voltage drop calculator](#)
- [Fixture installation manual](#)
- [Housing installation manual](#)
- [CAD files](#)
- [IES-LTD data](#)

### Note

Underwater luminaire – must be constantly submersed.



## Arpool M

### ORDERING INFORMATION

#### MODEL

AM

#### APPLICATION

TM

- TM - Ø100mm x 99mm (Ø3,9" x 3,9")

#### POWER

L

- L - 9W, 2700/3000/4000K, 600 lm

H

- H - 15W, 2700/3000/4000K, 1100lm
- H - 15W, TW (2200-4000K)
- H - 15W, RGBW (W 4000K)

#### COLOR TEMP.

27

- 27 - 2700K

30

- 30 - 3000K

40

- 40 - 4000K

T6

- T6 - Tuneable white 2200K-4000K

M5

- M5 - RGBW (W 4000K)

#### OPTICS

SP

- SP - Spot (15°)

MF

- MF - Flood (40°)

WD

- WD - Wide (70°)

#### VOLTAGE

12

- 12 - 12VDC fixture voltage

24

- 24 - 24VDC fixture voltage

#### OPTIONS

03

- 03\* - Standard feed cable 3m (10')

06

- 06 - Luminaire supplied with 6m (20') feed cable

09

- 09 - Luminaire supplied with 9m (30') feed cable

15

- 15 - Luminaire supplied with 15m (50') feed cable

20

- 20 - Luminaire supplied with 20m (65') feed cable

#### INTERNAL LIGHT

#### CONTROL

2

- 2 - Hex Louvre

4

- 4 - Half Moon

5

- 5 - Honeymoon



## Arpool M

### MANDATORY ACCESSORIES

#### Housings

##### HOUSING

**AM382**

- AM382 - Concrete pool installation housing back feed

**AM382S**

- AM382S - Concrete pool installation housing side feed

**AM382SP**

- AM382SP - Stainless steel pool installation housing

**AM382LN**

- AM382LN - Liner pool installation housing

#### Power supplies

##### DRIVERS

[LINK](#)

- List of available drivers

### OPTIONAL ACCESSORIES

**205117**

- 205117 - Socket wrench for cable gland



## Arpool M

### INSTALLATION DETAILS

#### Fixture

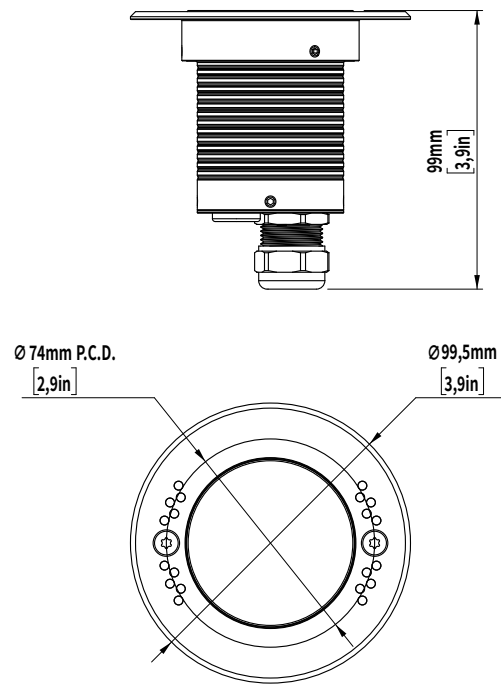

**Note:**

For details on specific depths, tiling thickness and other please refer to both Installation instructions for fixture and housing.



## Arpool M

### INSTALLATION DETAILS

#### Housings

AM382 - Concrete Pool Installation back feed

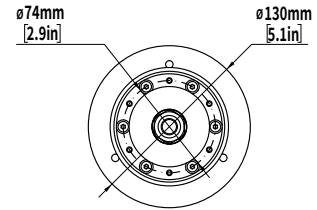
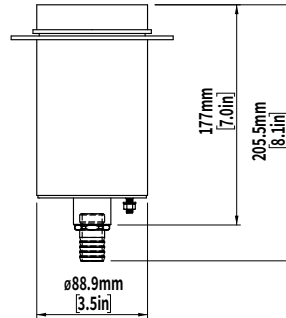

AM382S - Concrete Pool Installation side feed

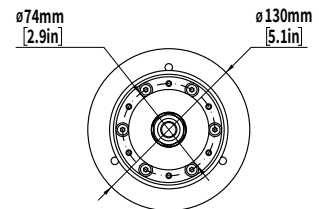
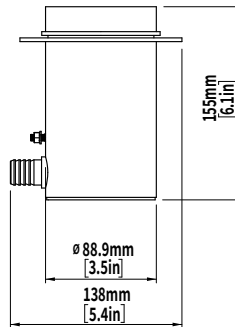

AM382SP - Stainless Steel Pool Installation

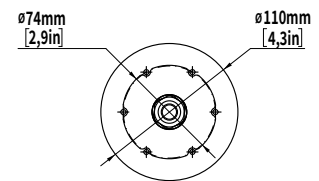
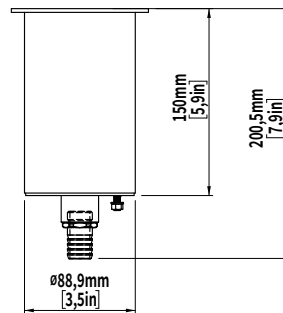

AM382LN - Liner Pool Installation

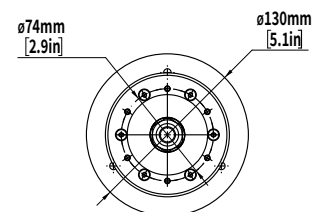
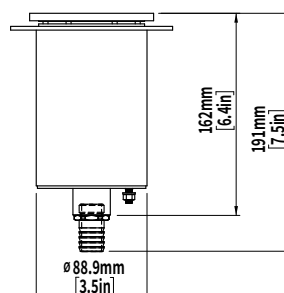

Note:  
For details on specific depths, tiling thickness and other please refer to both Installation instructions for fixture and housing.



## Arpool M

### MANDATORY ACCESSORIES

#### AISI316 installation housing

Stainless steel niche used to seamlessly integrate luminaire utilizing precision press fit with no exposed hardware. The housing, chemically etched and passivated, is suitable for marine and pool environments. Standard feature include a 1.5m oil and water-resistant cable conduit, streamlining the installation process. Due to its size, the housing's back end intentionally lacks a sealed cable gland. Contractors are advised to review installation instructions for proper guidance.

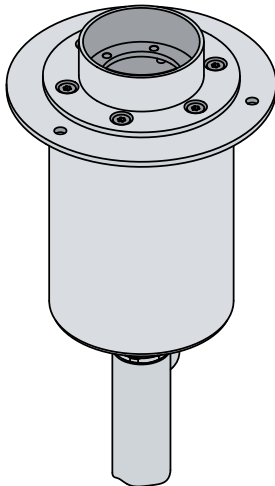

#### Power supply

A LED power supply, is an electrical device designed to control the power supplied to an LED or an array of LEDs. It plays a critical role in LED lighting systems as LEDs demand a specific type and level of electrical current or voltage for optimal operation. It's important to note whether a constant current or constant voltage LED power supply is required. The power supply should be installed in a dry and easily accessible area.

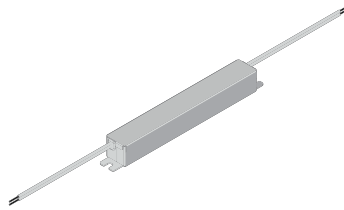



## Arpool M

### LIGHT CONTROL

#### Internal light control:

##### Hex louvre

Provides low glare control with 45% less lumen output than product without louvres. Best for use when there is no need for segment beam cut off such as in half moon.

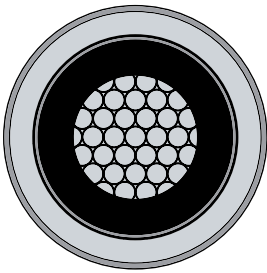

##### Half moon

Provides glare control by reducing lumen output and implementing a light beam cut-off, resulting in a 50% reduction in stray light and minimized light dispersion in undesirable directions.

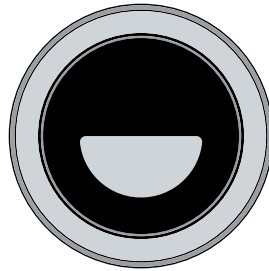

##### Honeymoon

Combines the benefits of Hex Louvre and Halfmoon, offering both reduced glare and controlled light dispersion for comprehensive glare management.

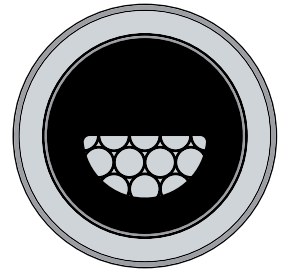



# Arpool M

## OPTICS

**Spot**  
Angle: 15°  
Delivered lumen: 1100lm

**Flood**  
Angle: 40°  
Delivered lumen: 800lm

**Wide**  
Angle: 70°  
Delivered lumen: 600lm

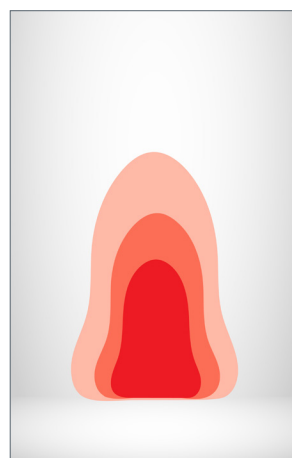
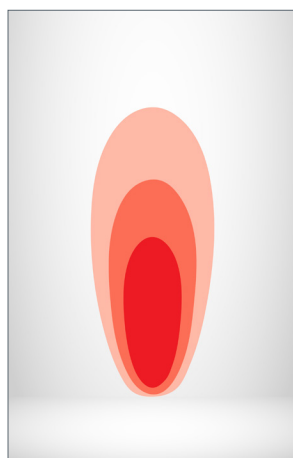
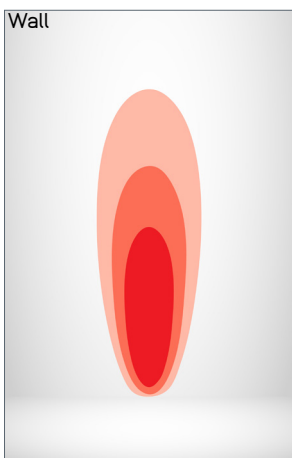
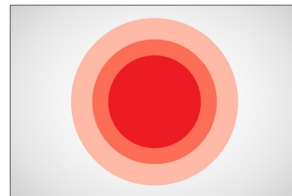
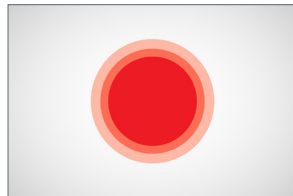
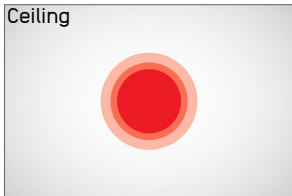

**Spot + Hex**  
Angle: 15°  
Delivered lumen: 550lm

**Flood + Hex**  
Angle: 40°  
Delivered lumen: 385lm

**Wide + Hex**  
Angle: 70°  
Delivered lumen: 275lm

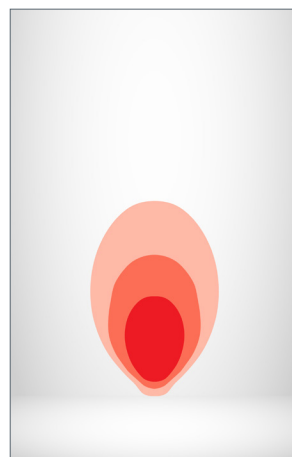
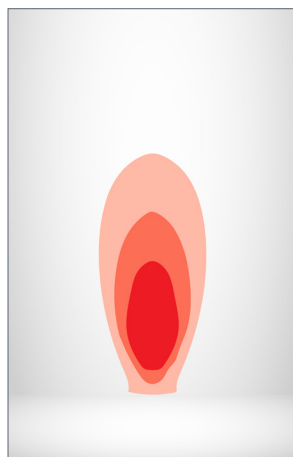
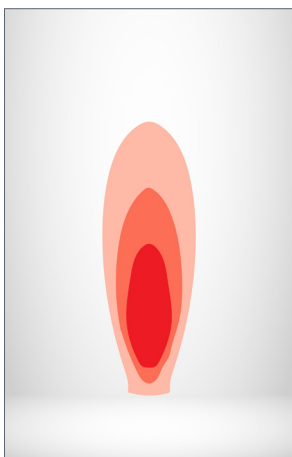
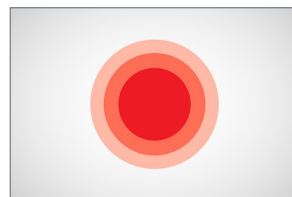
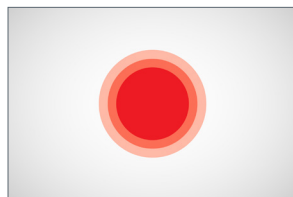
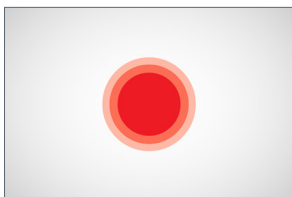

### Notes

- Light output values based on 15W and 4000K product



## Control

### PWM SYSTEM TOPOLOGY - CONSTANT VOLTAGE

#### System components

- The luminaire is supplied with a factory-installed feed cable in standard lengths for connection to the PSU circuit, and mounting hardware as specified in the installation instructions.
- A remote constant voltage power supply (12V / 24V DC), DC distribution cabling between the PSU and luminaires (if required), junction boxes, connection infrastructure, and the control system (DALI, DMX, 0–10V or switching) must be provided by the installer or customer.
- Recommended components:
  - Surge protection on the AC side of the PSU
  - Appropriately sized DC cabling to limit voltage drop
  - Connectors and junction boxes suitable for the installation environment

#### System topology

- In the system design, any of the following system topologies can be utilized: line wiring, star wiring, or tree wiring.

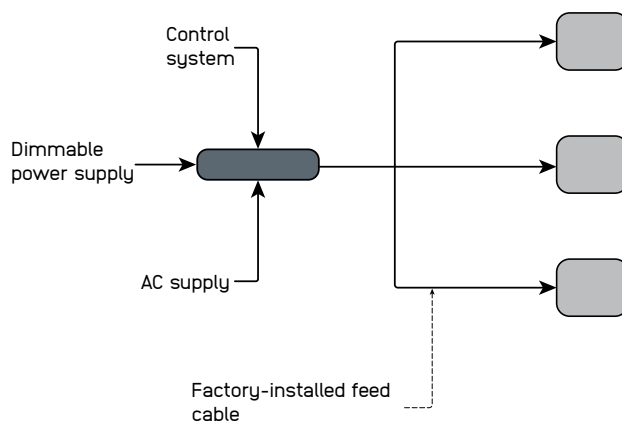

#### Addressing & dimming notes

- Constant voltage systems use a parallel connection topology typical for constant voltage lighting systems. Distribution layouts may include star topology, tree topology, or daisy-chain distribution.
- Individual device or channel addressing can be achieved by connecting each product to a separate output channel of the DALI or DMX dimmable power supply.
- The PSU adjusts output power according to the control signal using PWM dimming.
- Dimming options depend on the PSU and the selected control system.

#### Segment length and limitations

- The minimum controllable segment is one product
- Maximum cable length and number of luminaires depend on the PSU, total system wattage, conductor cross-section, and acceptable voltage drop.
- Voltage drop must remain within 10% of the nominal input voltage to ensure uniform light output.
- Dimming options depend on the PSU and the selected control system.

#### Fault tolerance

- Failure of the control system or communication bus does not interrupt luminaire operation if the PSU continues to supply power.
- Failure of one luminaire does not affect other luminaires connected to the same distribution line due to the parallel connection topology.
- System reliability depends on correct PSU sizing and proper electrical installation.